

Features

- 50,000 Hours LED Life
- Integrated E-Z On/Off Memory Sensor Dimmer
- Color temp selector 3000K, 4000K, 5000K
- 3720 Lumens
- CRI 90
- Integrated Defogger On/OFF
- 3x Lighted Magnifying Make up Mirror

Construction

- Quality polished edge mirror
- Single phase wire installation
- 5 MM Silver Backed Copper Free
- Installation Either Surface Mount
- Krugg Safe Glass
- Automatic Interior Lighting
- Includes installation hardware

Codes/Standards Applicable

- Conforms to UL Std. 962
- Cert. to CSA Std. C22.2 No.250.0-08
- ETL Intertek 5004931

Electrical System

Cabinet 2436:

- 120Vac, 60Hz, 56W
- Electric Current: 0.47A
- Wattage: 56W

Model

- ARGO 2436L Left Swinging Doors

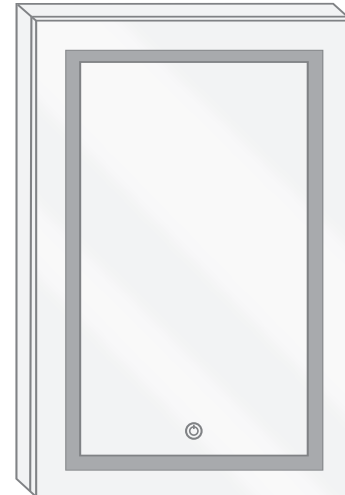

Electrical System

Cabinet 2436 Lighted/Electric

- Performance Requirments: Contains the required
- Supervisory Circiut with the Auto-Monitoring Function as noted by UL 1310
- Input Voltage: Min 112Vac, Nom 125Vac, Max 137Vac
- Frequency: 60Hz
- Front Receptacle Current: 102-132Vac Nominal 15A
- USB Output Current: 5VDC Nominal 4A

Deffogger (requirements for each cabinets):

- 12Vac, 60Hz, 18W
- Electric Current: 1.5A
- Wattage: 18W

SKU

- Name: ARGO 2436L
- Height: 36", Width: 24"
- Weight: 55lbs, Shipping weight: 60lbs

CABINET CONFIGURATION

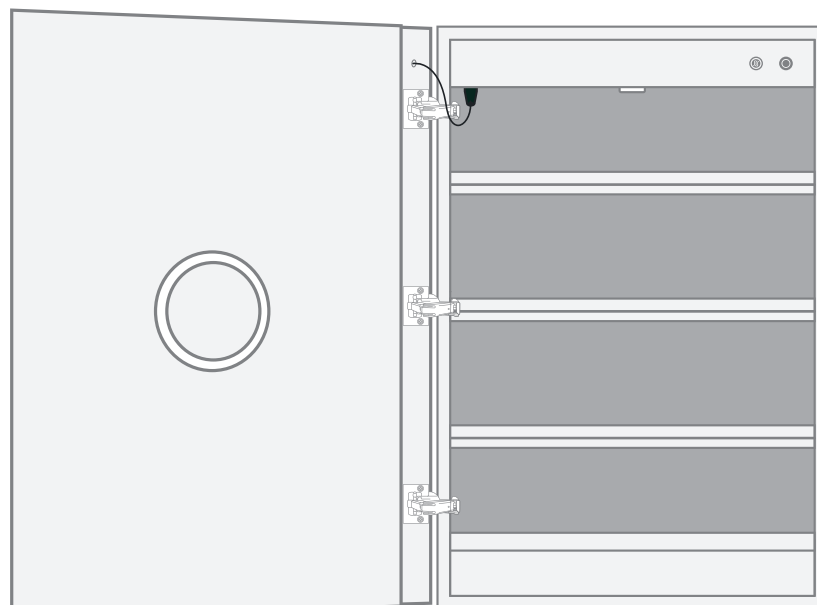

ARGO 2436L LED Medicine Cabinet - Specification Sheet

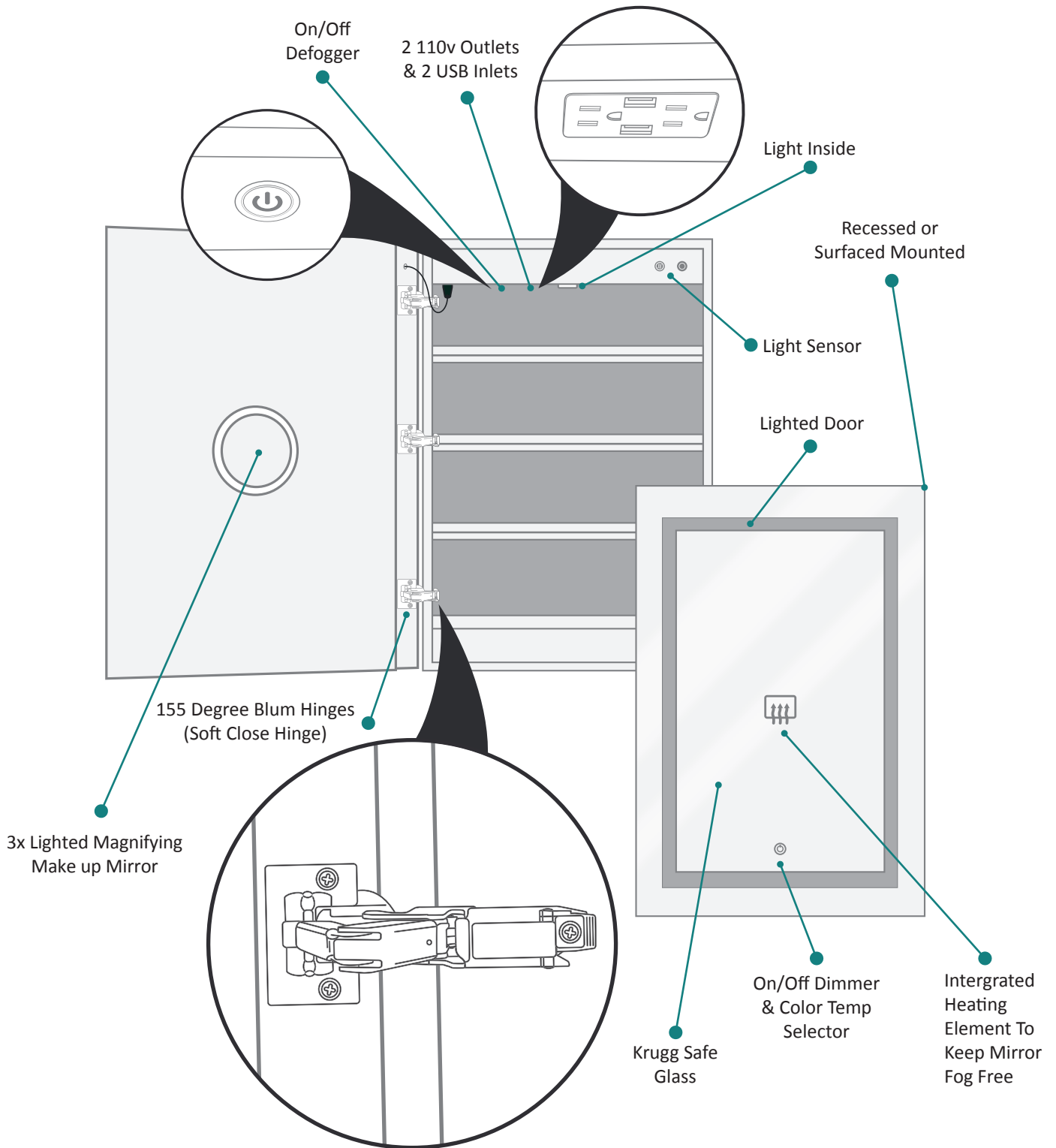

SURFACE MOUNT

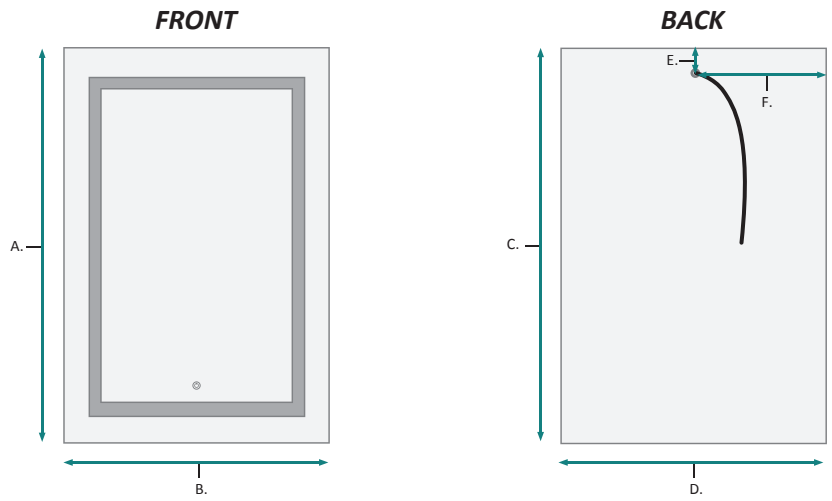
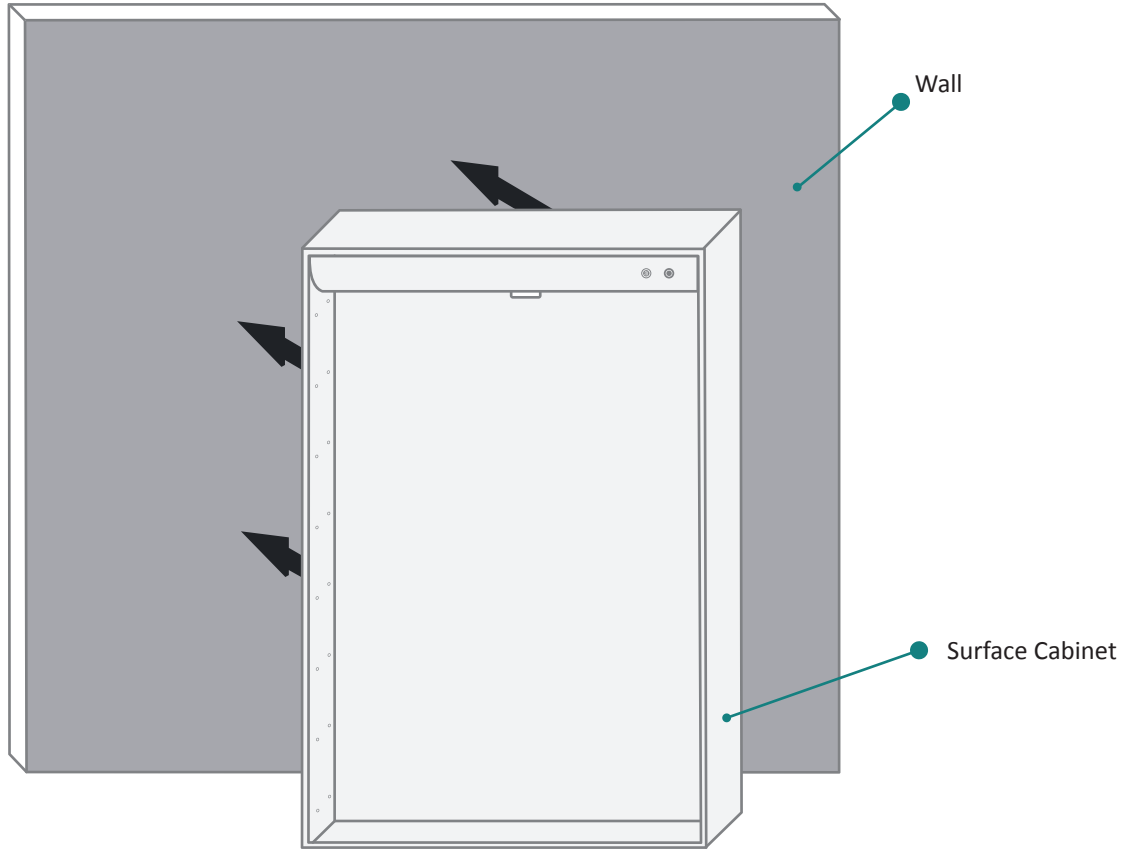

FRONT & BACKS

MODEL	A	B	C	D	E	F
ARGO2436L	36	24	36	24	1-1/8	11-1/4

These measurements are for reference, for best results we suggest you measure actual product as small variations in size are possible

RECESSED MOUNT

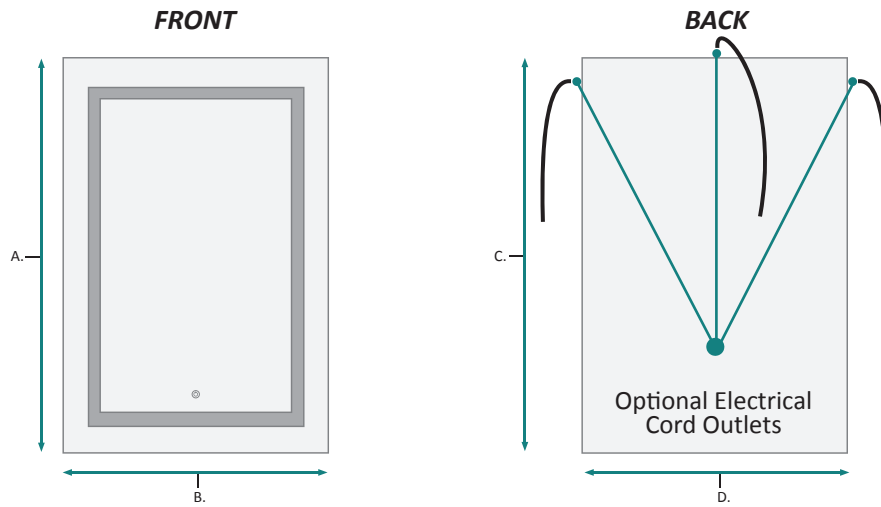
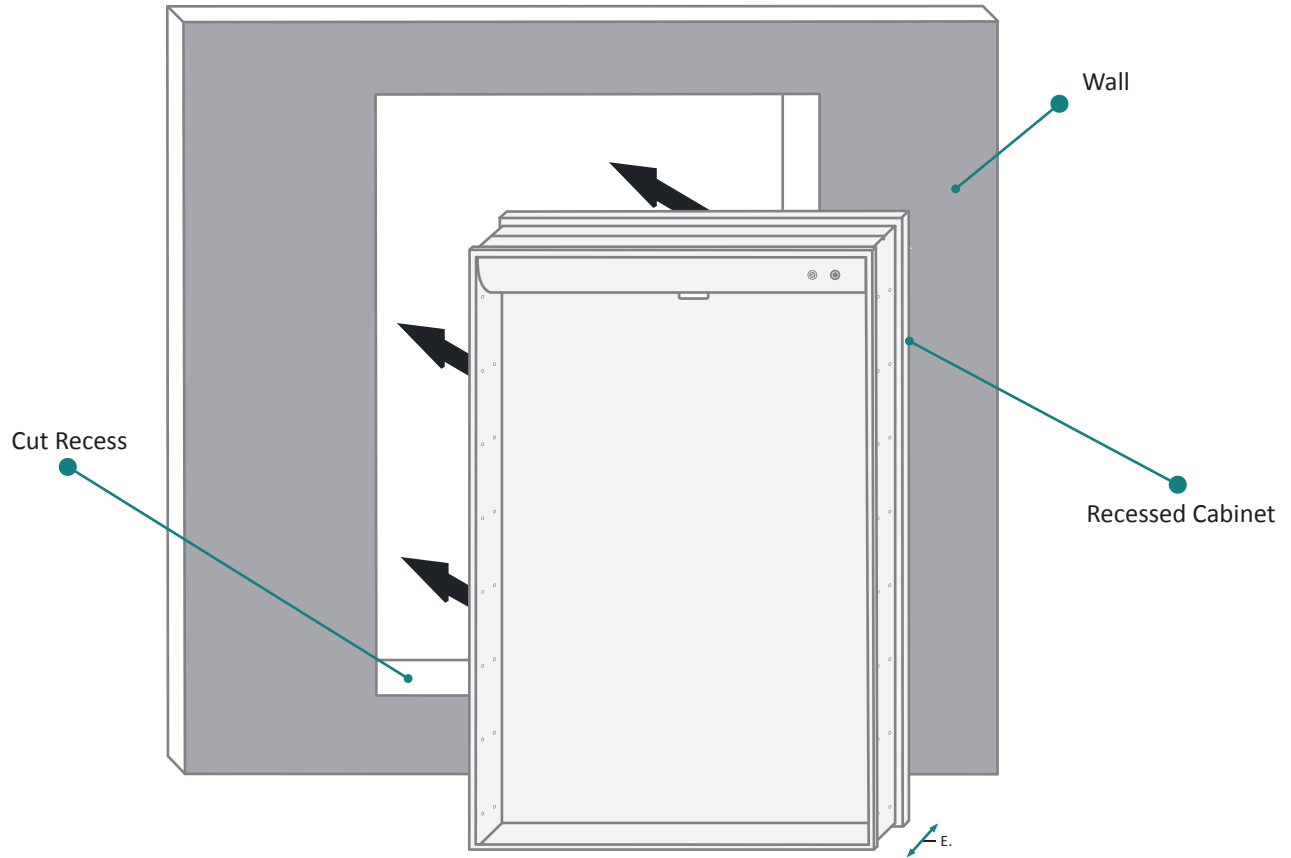

FRONT & BACKS

MODEL	A	B	C	D	E
ARGO2436L	36	24	35-1/8	23-1/8	3-1/2

These measurements are for reference, for best results we suggest you measure actual product as small variations in size are possible

RECESS INSTALLATION OPTIONAL ELECTRICAL CORD LOCATIONS

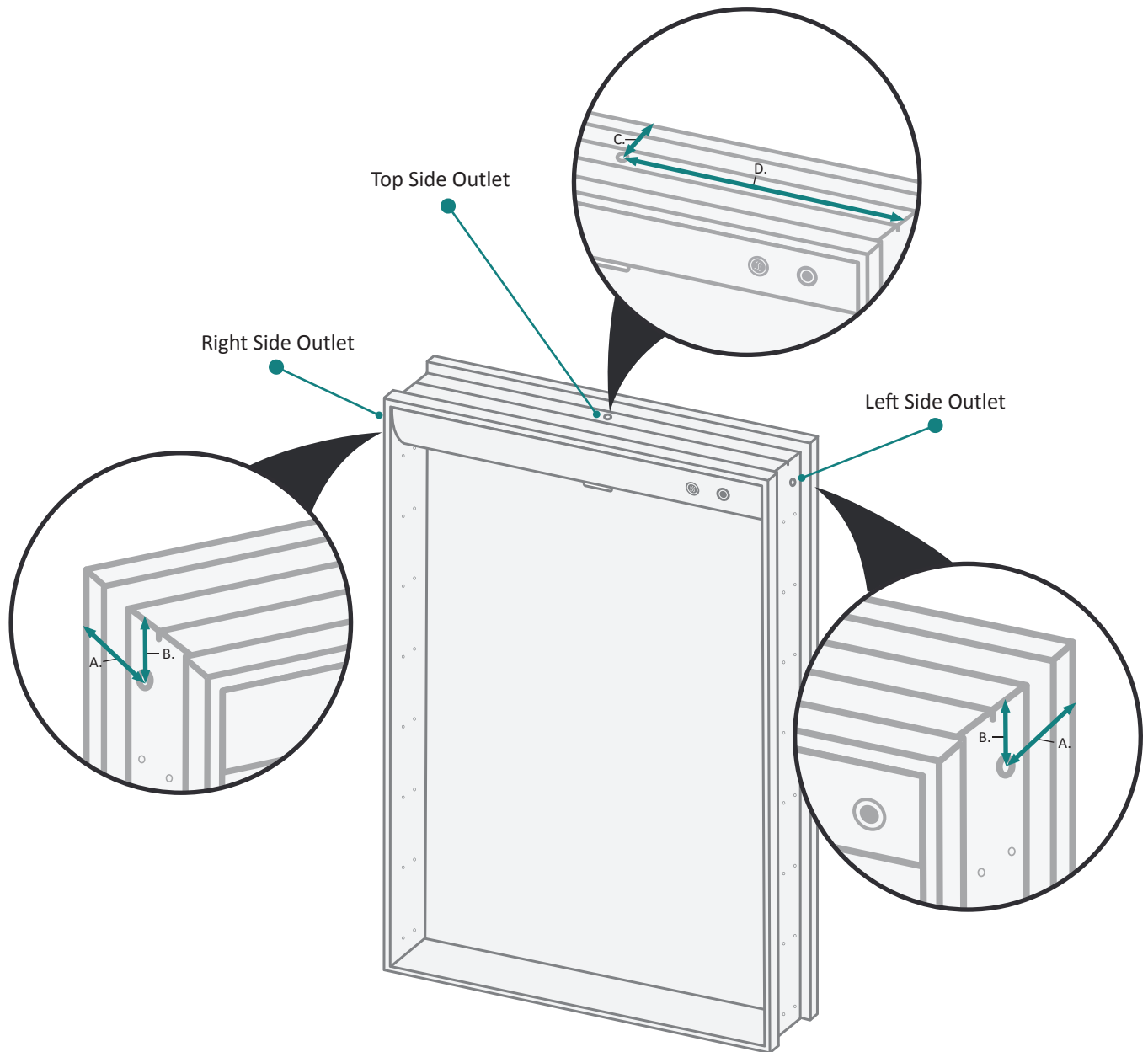

ELECTRICAL CORD LOCATIONS

MODEL	A	B	C	D
ARGO2436L	1-1/8	1-1/8	1-1/8	11-1/4

These measurements are for reference, for best results we suggest you measure actual product as small variations in size are possible

ARGO 2436L LED Medicine Cabinet - Specification Sheet

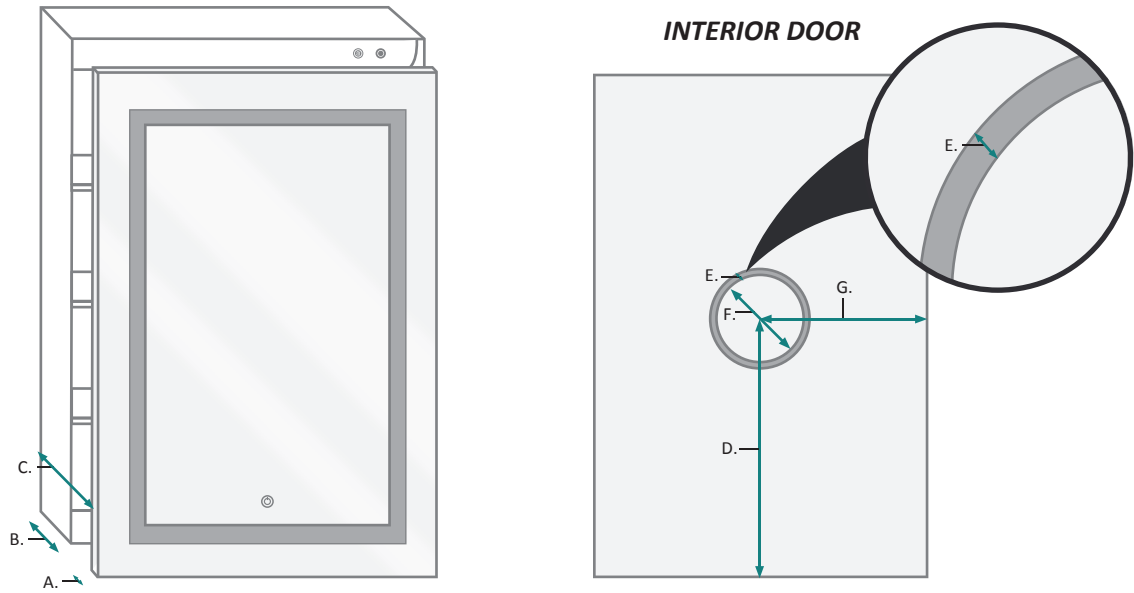

DOOR & CABINET

MODEL	A	B	C	D	E	F	G
ARGO2436L	7/8	3-1/2	4-3/4	17-1/4	3/8	5-1/4	11-1/4

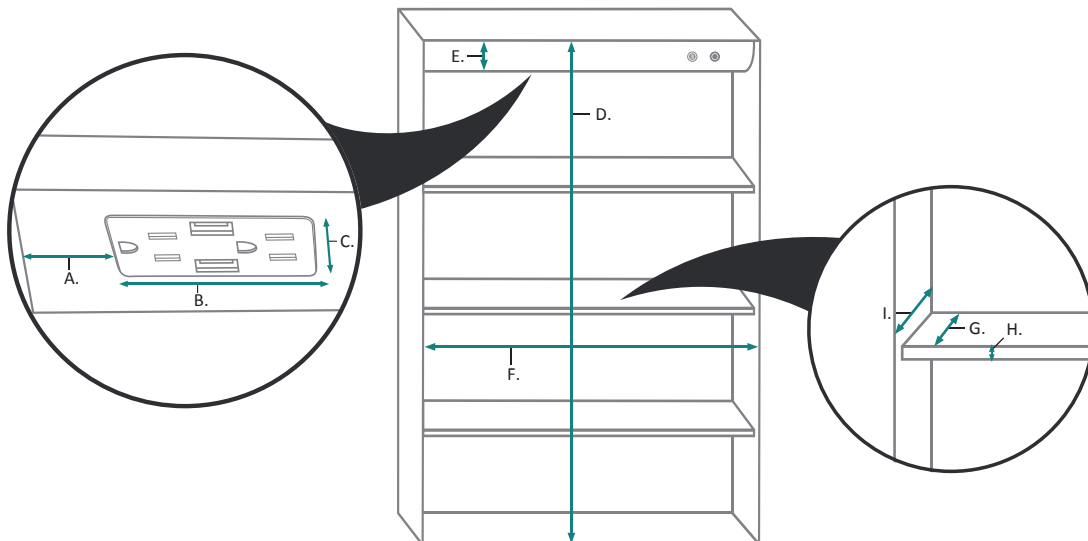

INTERIOR CABINET

MODEL	A	B	C	D	E	F	G	H	I
ARGO2436L	3-3/4	5-5/8	1-1/4	34-1/2	2-1/4	22-1/4	2-3/8	3/8	3-5/8

These measurements are for reference, for best results we suggest you measure actual product as small variations in size are possible