

ARGO 1242R LED Medicine Cabinet - Specification Sheet



Features

- 50,000 Hours LED Life
- Integrated E-Z On/Off Memory Sensor Dimmer
- CRI 90
- Integrated Defogger On/OFF

Construction

- Quality polished edge mirror
- Single phase wire installation
- 5 MM Silver Backed Copper Free
- Installation Either Surface Mount
- Krugg Safe Glass
- Automatic Interior Lighting
- Includes installation hardware

Codes/Standards Applicable

- Conforms to UL Std. 962
- Cert. to CSA Std. C22.2 No.250.0-08
- ETL Intertek 5004931

Electrical System

Cabinet 1242:

- 120Vac, 60Hz, 18.5W
- Electric Current: 0.15A
- Wattage: 18.5W

Model

- ARGO 1242R Right Swinging Doors



Electrical System

Cabinet - 1242 Electric

- Performance Requirments: Contains the required
- Supervisory Circiut with the Auto-Monitoring Function as noted by UL 1310
- Input Voltage: Min 112Vac, Nom 125Vac, Max 137Vac
- Frequency: 60Hz
- Front Receptacle Current: 102-132Vac Nominal 15A
- USB Output Current: 5VDC Nominal 4A

Deffogger (requirements for each cabinets):

- 12Vac, 60Hz, 18W
- Electric Current: 1.5A
- Wattage: 18W

SKU

- Name: ARGO 1242R
- Height: 42", Width: 12"
- Weight: 50lbs, Shipping weight: 55lbs

CABINET CONFIGURATION

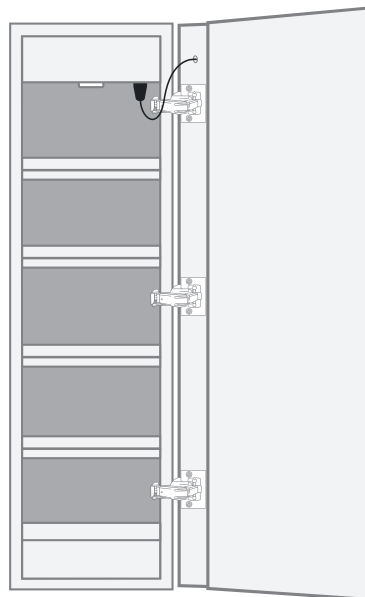

ARGO 1242R LED Medicine Cabinet - Specification Sheet

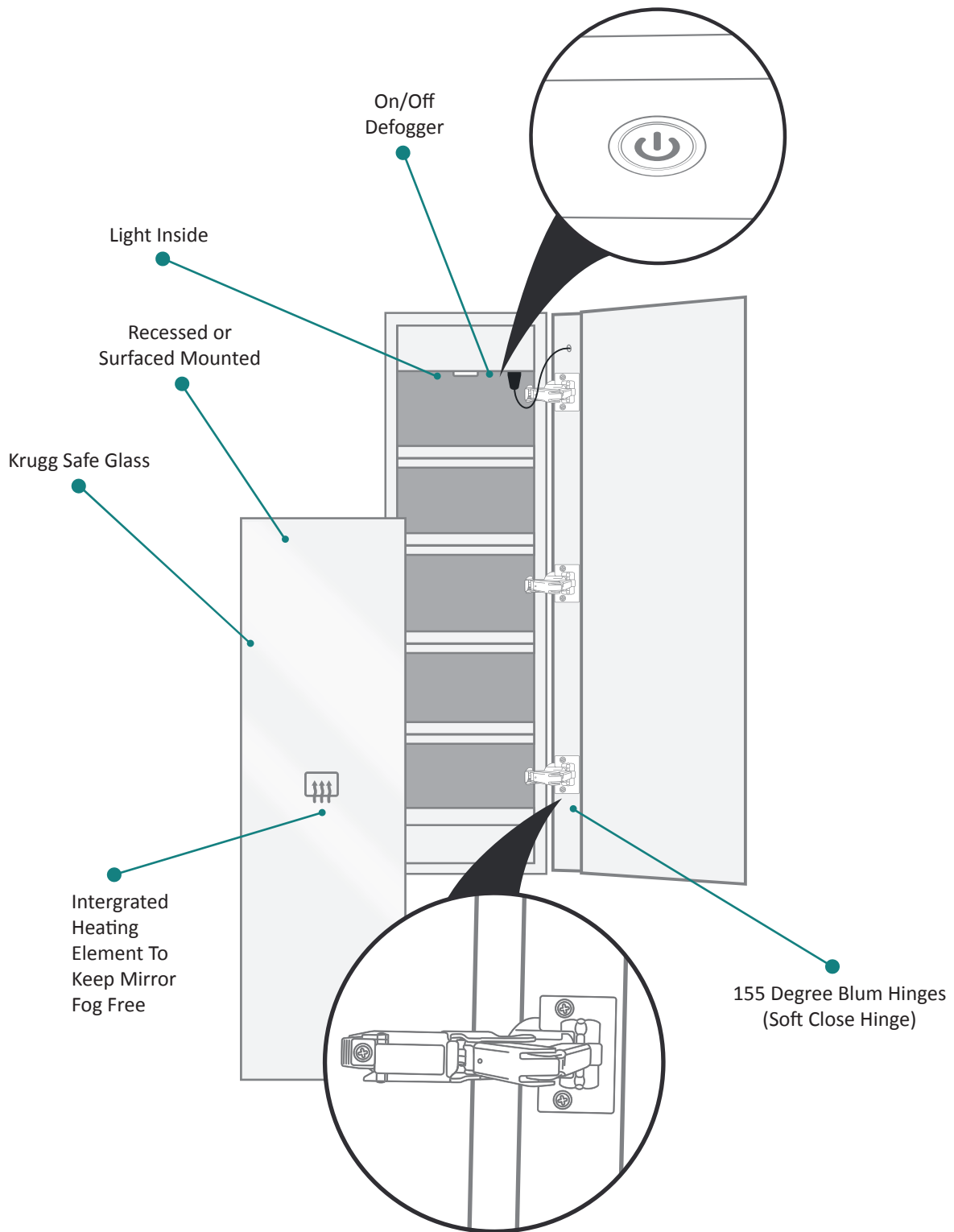

SURFACE MOUNT

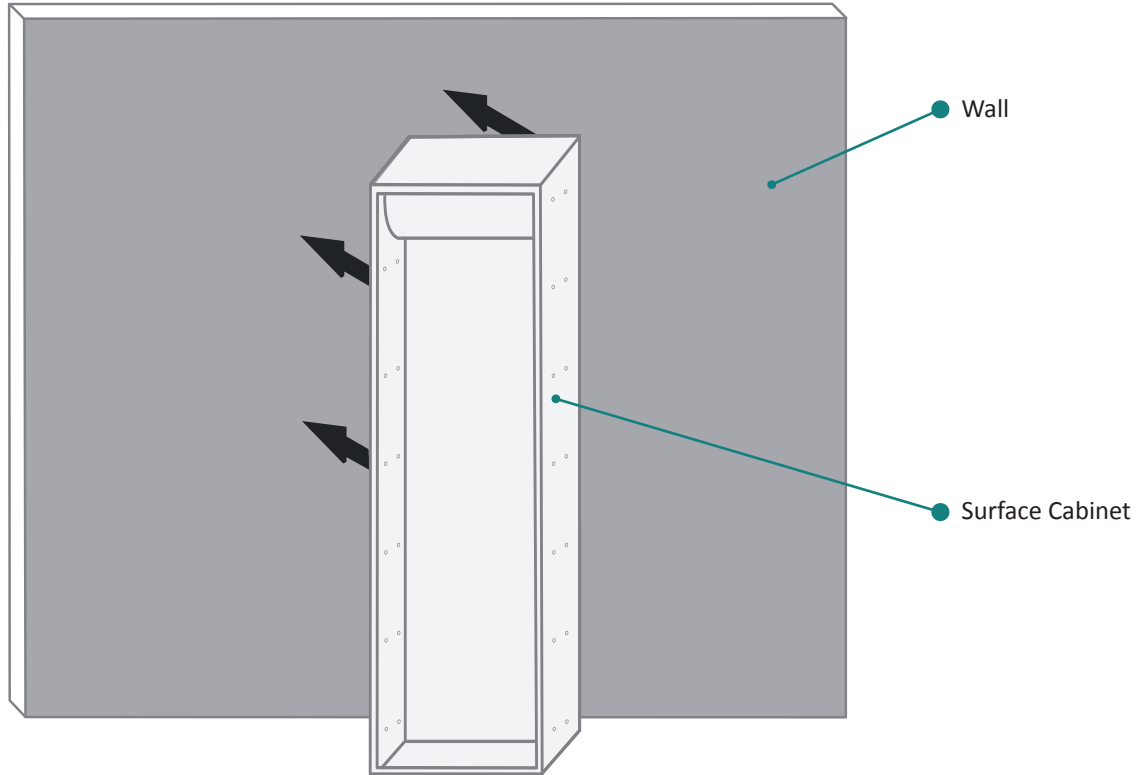

FRONT

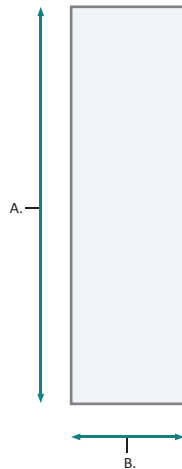

BACK

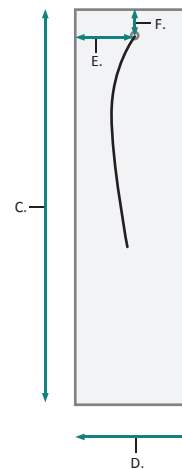

FRONT & BACKS

MODEL	A	B	C	D	E	F
ARGO1242R	42	12	42	12	5-1/4	1-1/8

These measurements are for reference, for best results we suggest you measure actual product as small variations in size are possible

RECESSED MOUNT

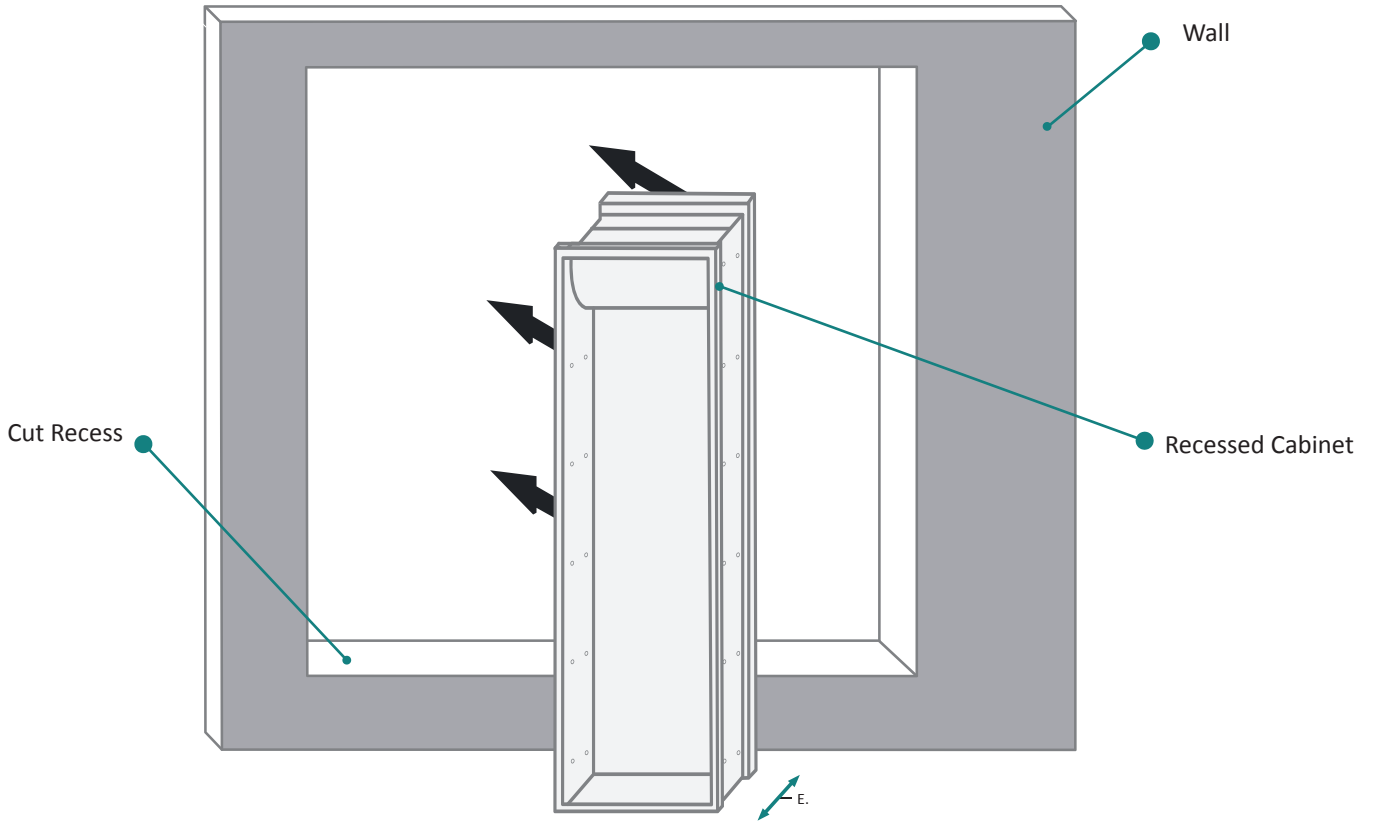

FRONT



BACK

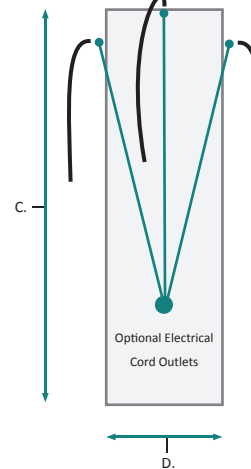

FRONT & BACKS

MODEL	A	B	C	D	E
ARGO1242R	42	12	41-1/8	11-1/8	3-7/8

These measurements are for reference, for best results we suggest you measure actual product as small variations in size are possible

RECESS INSTALLATION OPTIONAL ELECTRICAL CORD LOCATIONS

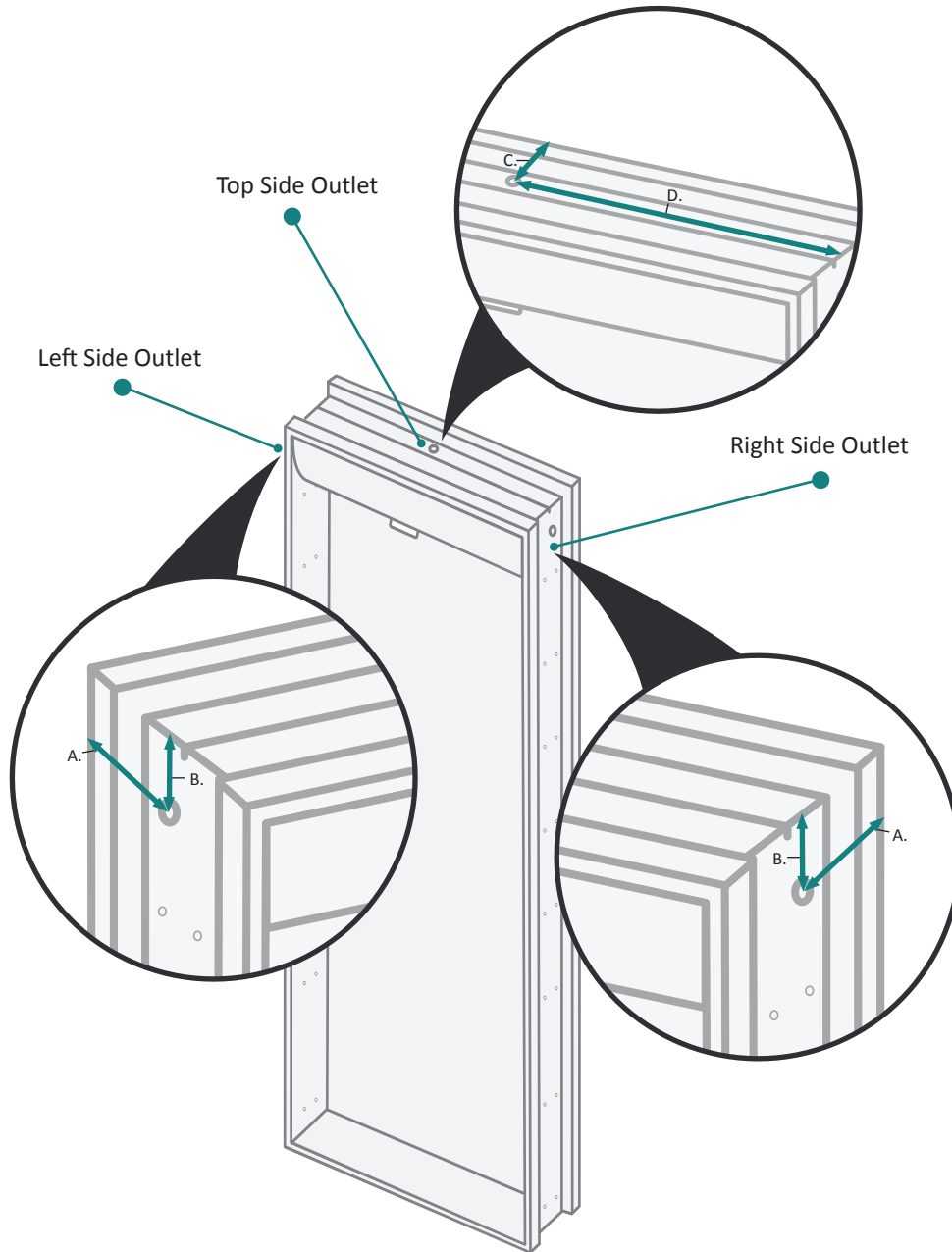

ELECTRICAL CORD LOCATIONS

MODEL	A	B	C	D
ARGO1242R	1-1/2	1-1/8	1-3/8	5-1/4

These measurements are for reference, for best results we suggest you measure actual product as small variations in size are possible

ARGO 1242R LED Medicine Cabinet - Specification Sheet

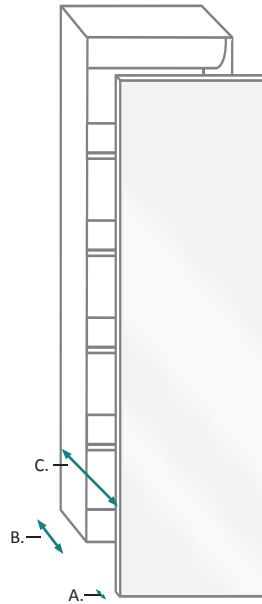

DOOR & CABINET

MODEL	A	B	C
ARGO1242R	7/8	3-7/8	4-3/4

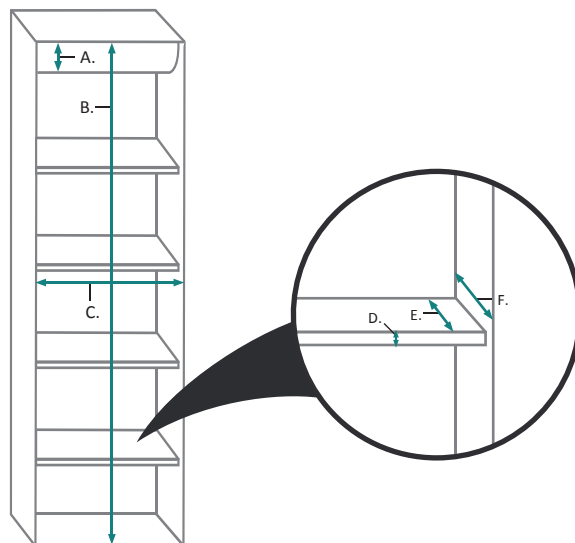

INTERIOR CABINET

MODEL	A	B	C	D	E	F
ARGO1242R	2-1/4	40-1/2	10-1/2	3/8	2-3/8	3-5/8

These measurements are for reference, for best results we suggest you measure actual product as small variations in size are possible